

**Spoj obrázky a tvary, které se podobají.**

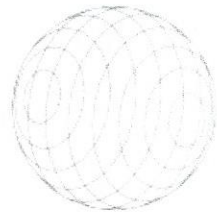

Vymodeluj čertovy rohy.

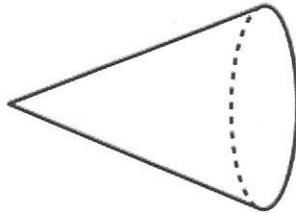
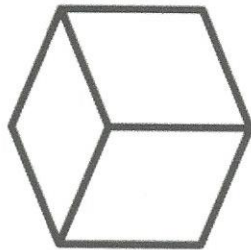
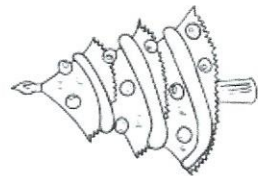
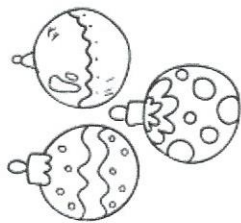
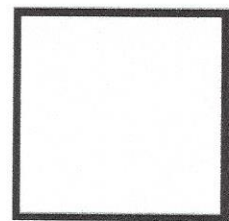
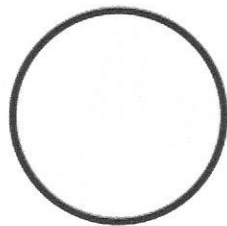
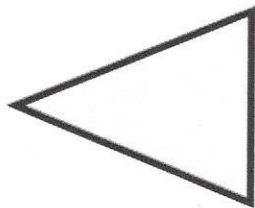
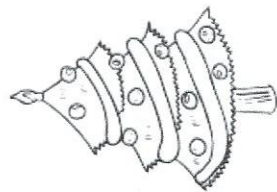
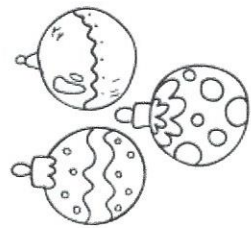
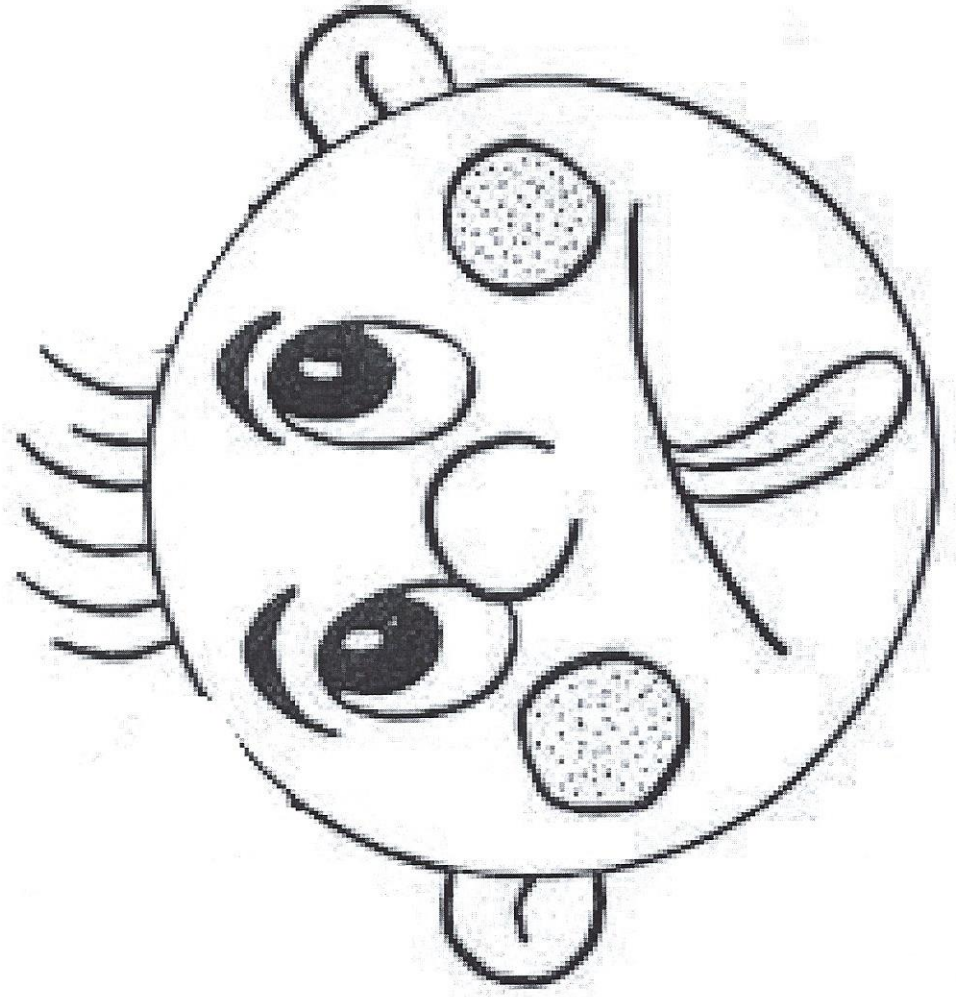

Ozdob vánoční stromeček.

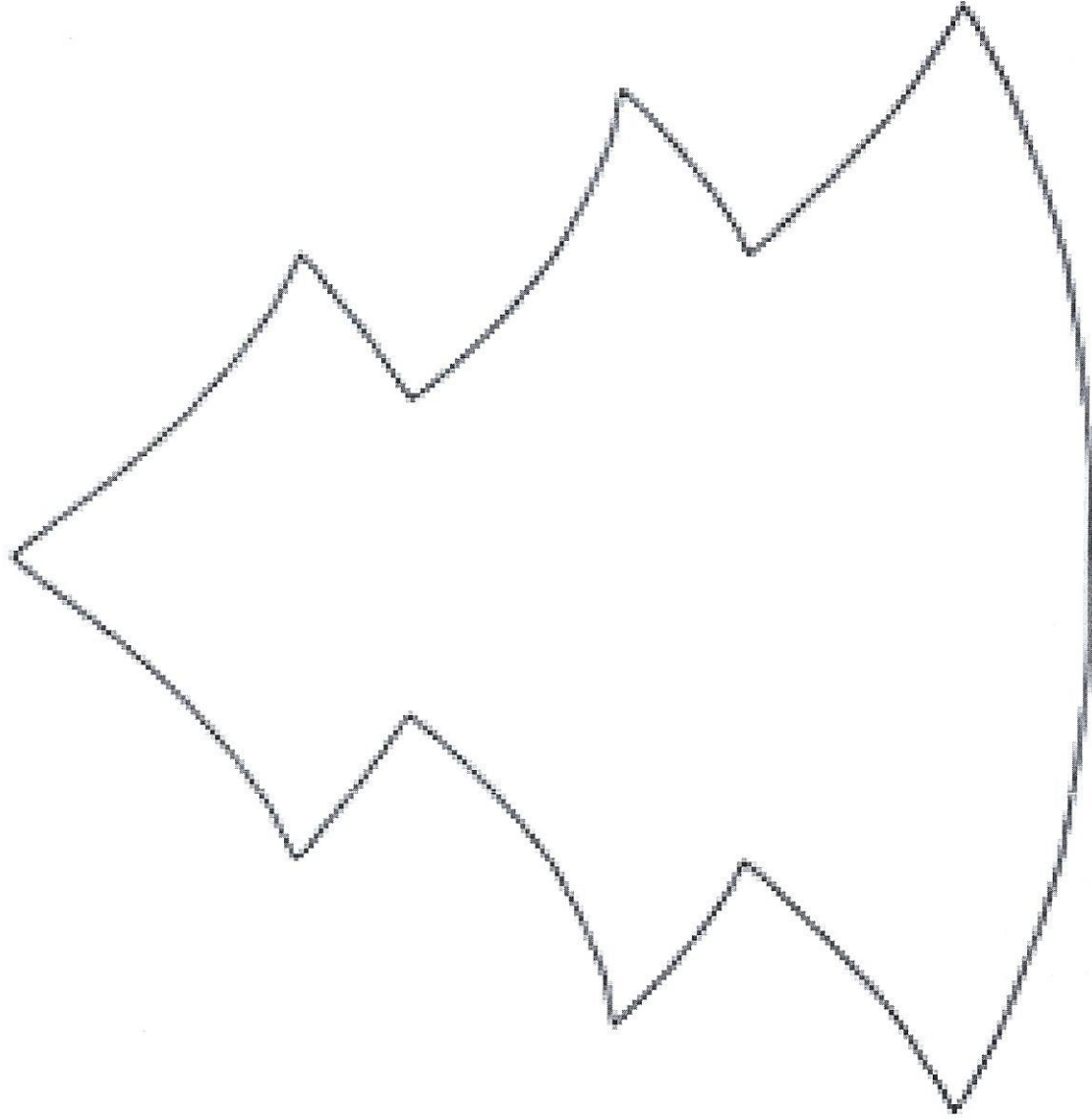

Předved' čerta když se zlobí.



Obkresli prstem cestičku.

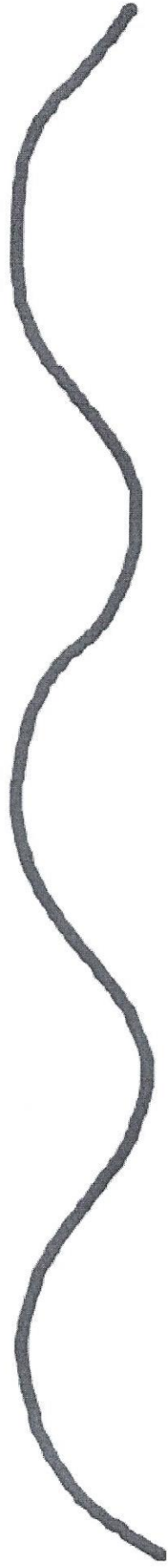

Poznáš, které dva obrázky se  
překrývají?

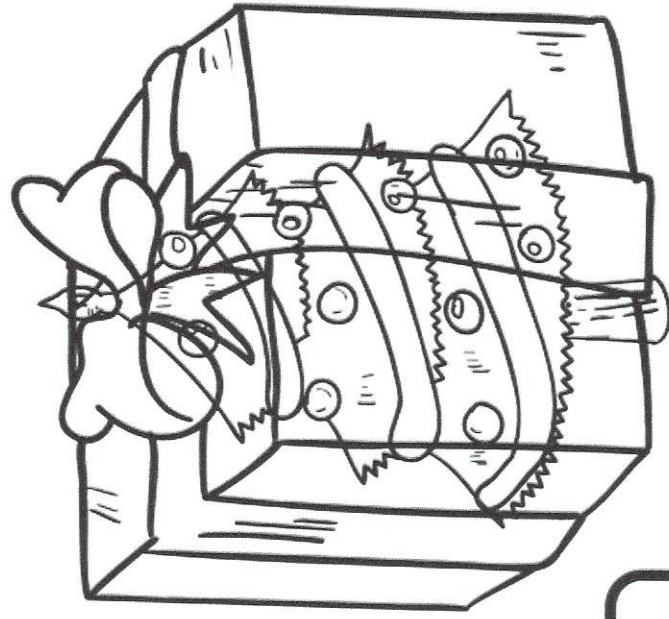
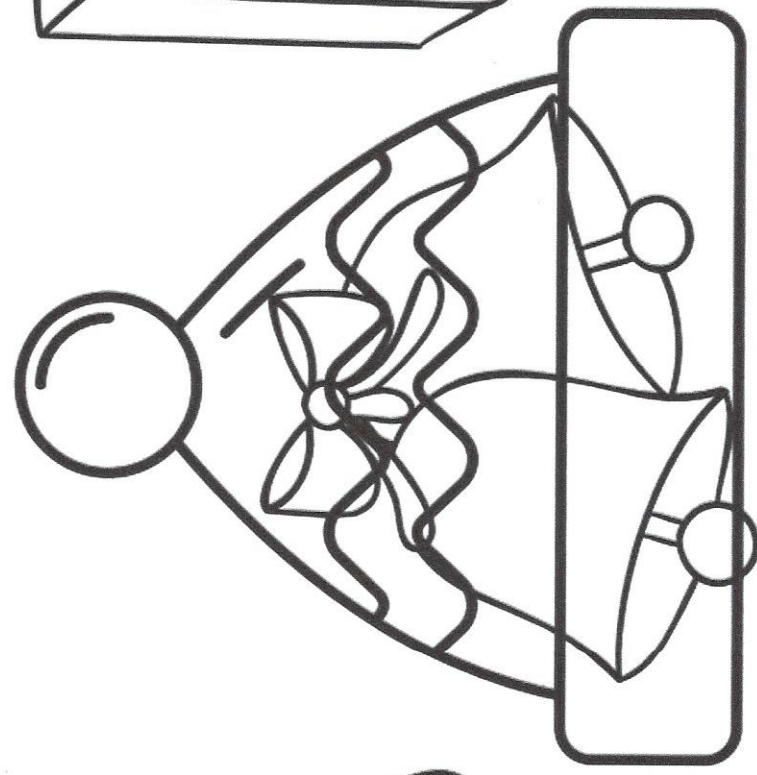
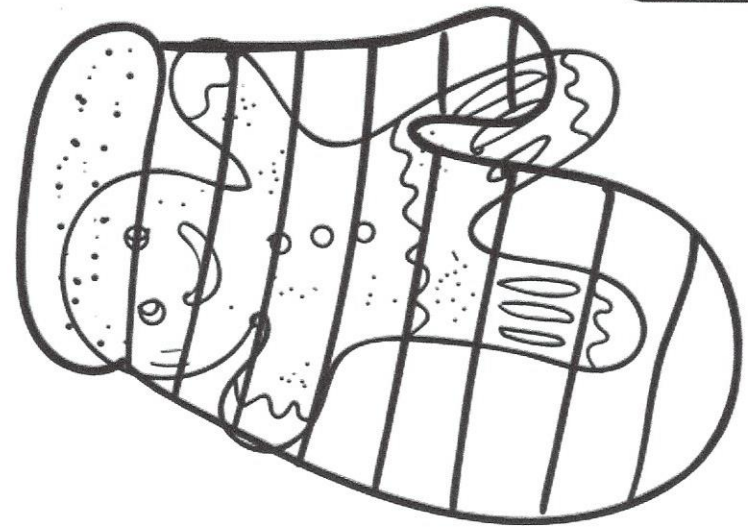

**Jaké obrázky jsou ukryté  
v rukavicích?**

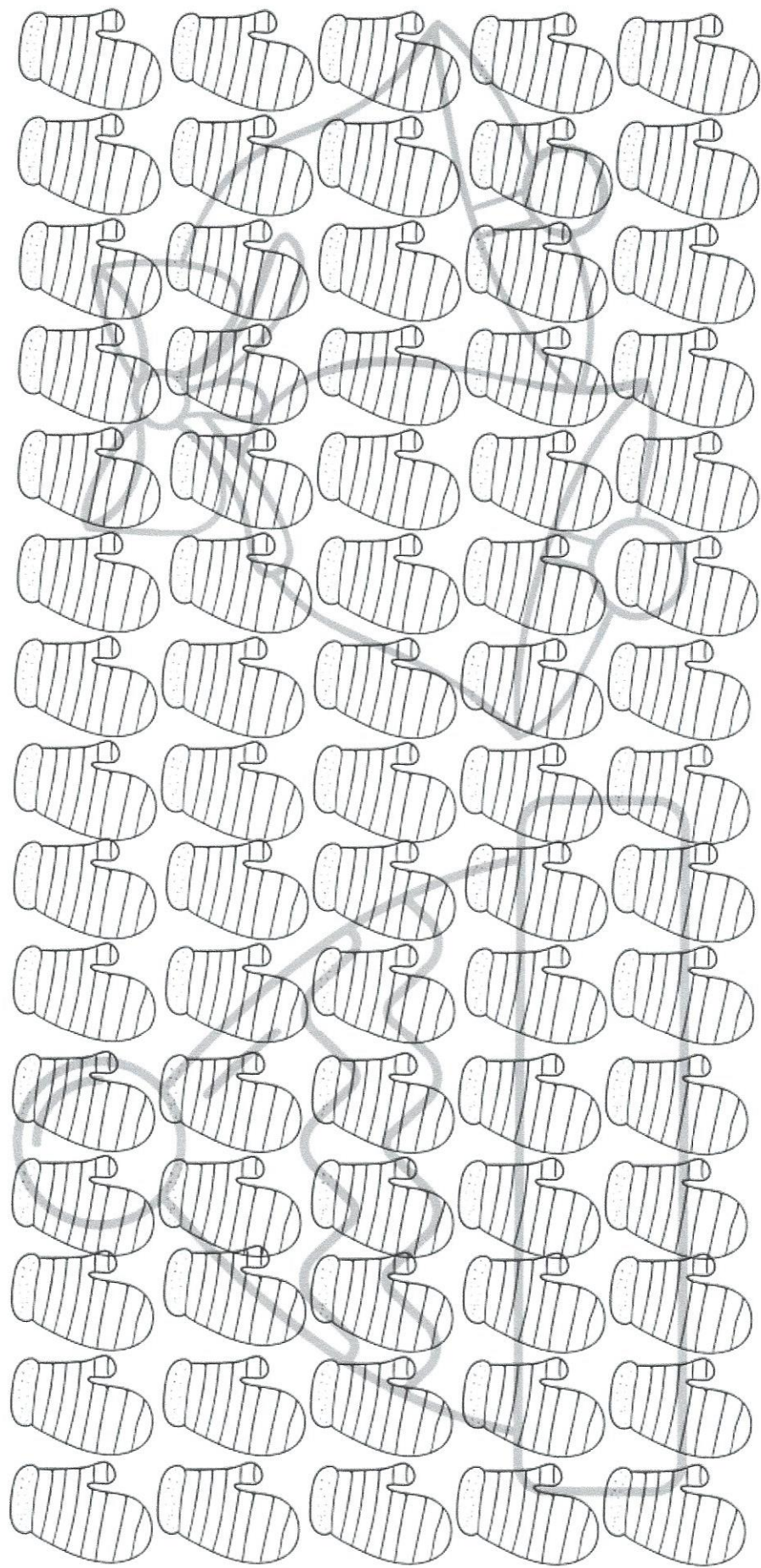

**Která část obrázku chybí?**

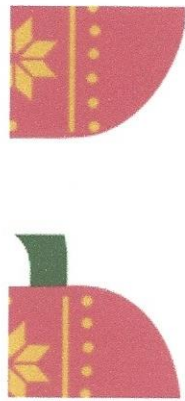



Přiřaď k barevnému obrázku jeho stín.

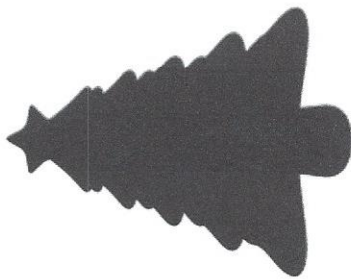
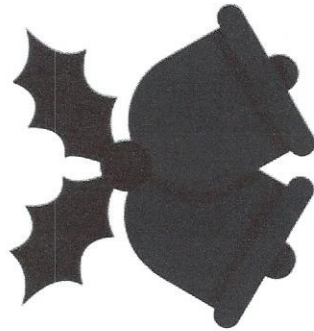
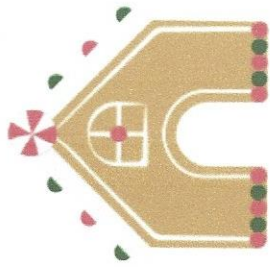
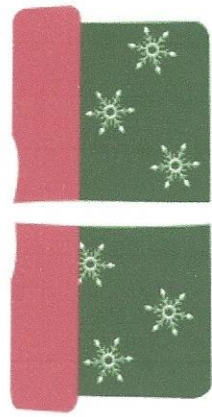

Najdi všechna písmena,  
která tvoří jméno:

**M I K U L Á Š**

---

**M I O V Á A Š**  
**N I K U L S**